

Edition 400
11519010000 Towel holder

PRODUCT

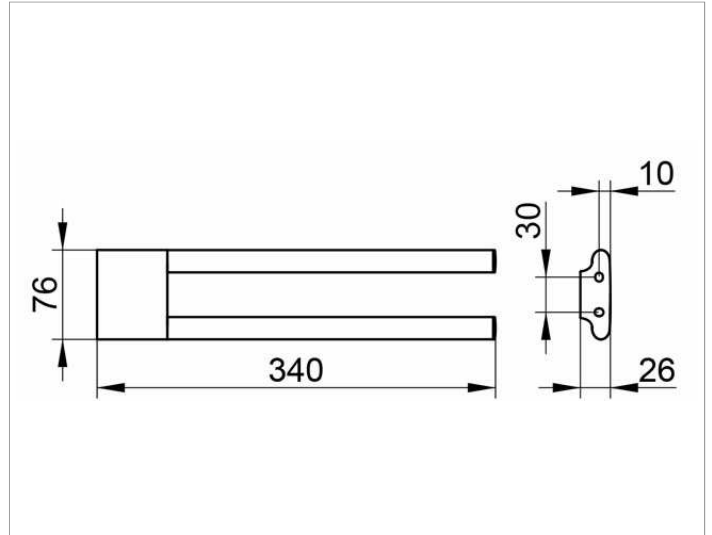

DRAWING



PRODUCT ATTRIBUTES

fixed

SURFACE

chrome-plated

DIMENSION

340 mm

SPECIFICATIONS

KEUCO Edition 400 towel holder, 11519010000
chrome-plated towel holder, 2 pieces,
sculptural design,
with slightly rounded edges,
two side by side,
fixed arms, made of oval tubes,
antistatic, easy to clean,
depth 340 mm, width 76 mm, height 26 mm,
the towel holder is fitted concealed,
delivery included anti-corrosion fixings