

Royal Match

12813171331 Mirror cabinet

PRODUCT



DRAWING

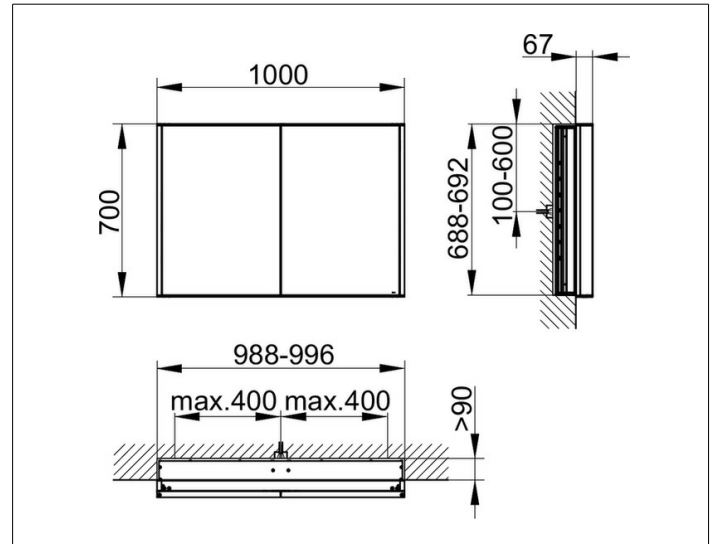

PRODUCT ATTRIBUTES

for recessed installation

2 hinged double sided crystal mirror doors,
body in aluminium silver anodized,
rear panel in back-lacquered white glass

Operation:

control panel with capacitive touch sensor,
optional to be operated via the light switch

Illumination:

LED 2 x 12,5 watt (lifespan > 30.000 hours),
light colour 3000 kelvin (warm white),
infinitely dimmable

EEK: C , 25 kWh/1000h

EQUIPMENT

- 1 shaver socket (internal)
- 2 x 3 adjustable glass shelves
- interior lighting

SURFACE

silver anodized

DIMENSION

1000 x 700 x 150 mm