

Royal Match

12812171331 Mirror cabinet

PRODUCT



DRAWING

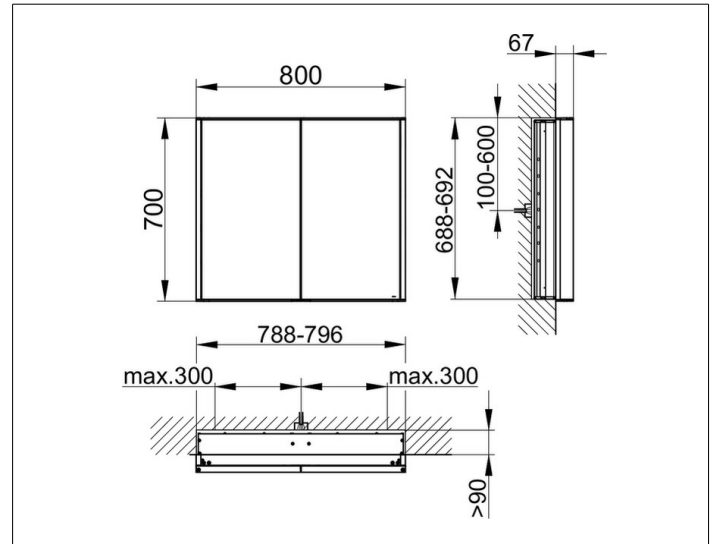

PRODUCT ATTRIBUTES

for recessed installation

2 hinged double sided crystal mirror doors,

body in aluminium silver anodized,

rear panel in back-lacquered white glass

Operation:

control panel with capacitive touch sensor,

optional to be operated via the light switch

Illumination:

LED 2 x 12,5 watt (lifespan > 30.000 hours),

light colour 3000 kelvin (warm white),

infinitely dimmable

EEK: C , 25 kWh/1000h

EQUIPMENT

- 1 shaver socket (internal)

- 2 x 3 adjustable glass shelves

- interior lighting

SURFACE

silver anodized

DIMENSION

800 x 700 x 150 mm